

# INSTRUCTION MANUAL ON *the TRACER*

(MODEL A-6)

METALLIC PIPE & CABLE LOCATOR

including instructions on the  
Inductive Coupler & Non-Metallic Pipe  
Locator, The Sewer & Mini Snooper

U.S. PATENT NO. 3,597,680

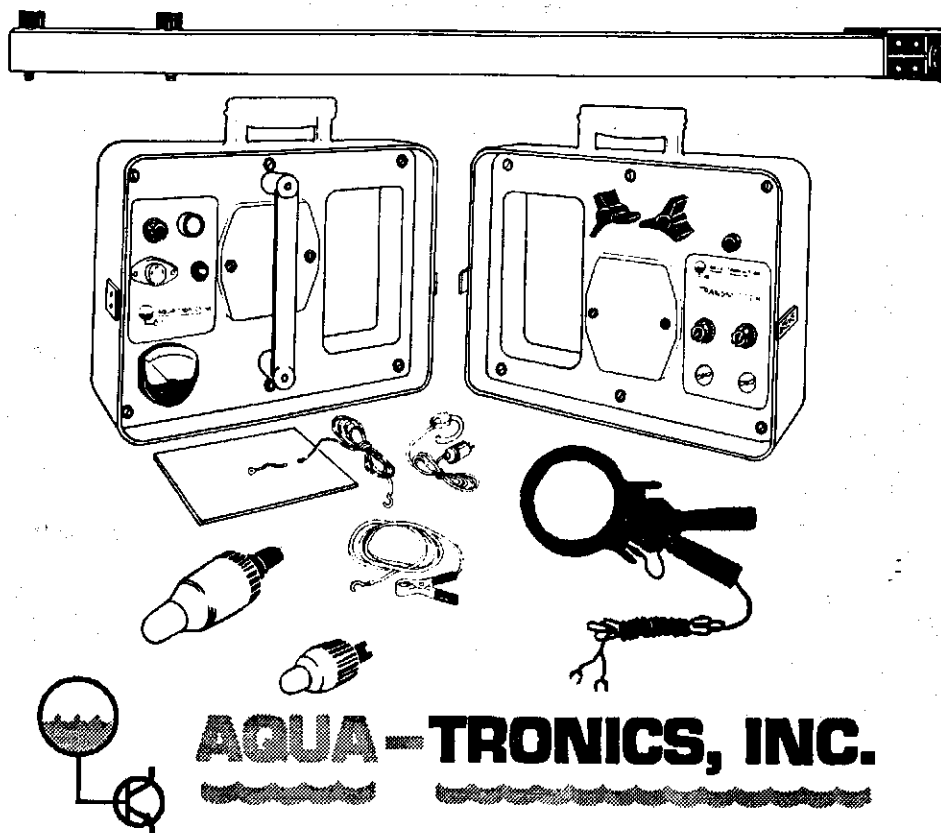

**AQUA-TRONICS, INC.**

1212 NE 5th St. • Redmond, OR 97756

Tel: (541) 548-2110

Fax: (541) 548-2117

Email: [aquatron@aquatronics.com](mailto:aquatron@aquatronics.com)

Web: [www.aquatronics.com](http://www.aquatronics.com)

# INSTRUCTION MANUAL

## Table of Contents

<b>I. DESCRIPTION (On-Handle, Direct or Inductive Tracing and Accessories)</b>	1
<b>II. OPERATING INSTRUCTIONS FOR THE MODEL A6 TRACER</b>	1
1. Battery Test	1
2. On-Handle Operation	1
A. Assembly Instructions for On-Handle	1
B. Adjusting for a Null Balance	1
C. Operating Hints – On-Handle	2
D. Summary – On-Handle	2
E. Locating a Manhole Cover	3
F. Locating a Pipe or Cable	3
G. Locating the Center of a Flat Metal Target	4
H. Locating Gate Valves or Water Meter Lids	4
3. Off-Handle Operation	5
A. Direct Tracing	5
B. Locating by the NULL Method	6
C. Locating the the MAXIMUM Method	6
D. Inductive Tracing	7
E. Tracing with the Inductive Coupler	7
F. Correcting a Wide or Broad Peak Reading	8
G. Determining Depth	9
<b>III. THEORY OF OPERATION</b>	10
<b>IV. OPERATING INSTRUCTIONS FOR SEWER SNOOPER OR MINI-SNOOPER</b>	11
<b>V. SERVICE AND WARRANTY</b>	15

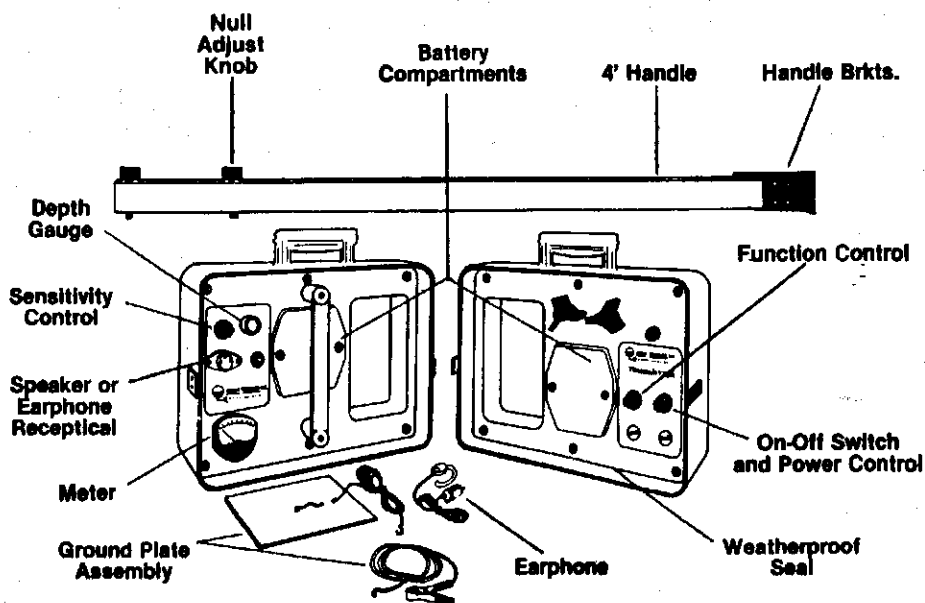

## I. DESCRIPTION

The Model A6 pipe & cable locator, the Tracer, is a transmitter-receiver type metal locator designed for locating metallic objects that are buried. (Cables, pipes, gate valves, vault lids, manhole covers, water meters, etc.) It can also be used to trace the exact route, position, and depth of a cable or pipe.

### 1. ON-HANDLE OPERATION

Used to locate cables, pipes, and other metallic objects as a metal locator. Since the locator is locating metal below ground, it *cannot* be used over reinforced concrete or inside a building in the on-handle mode.

### 2. DIRECT OR INDUCTIVE TRACING

By placing a tone on the line to be traced, the position and depth of the line can be found at any point.

### 3. ACCESSORIES FOR THE MODEL A6 TRACER

The Model I.C. 49 or I.C. 56 Inductive Coupler is used to isolate a line from other utilities even though they are sharing a common ground. The Sewer Snooper or Mini Snooper is used for locating non-metallic pipe and duct. These accessories are covered in this manual. See the Table of Contents for page number.

## II. OPERATING INSTRUCTIONS - Model A6 Tracer

The information presented herein is intended to familiarize the user with the instrument, and with some of the basic concepts in locating. Do not be discouraged if first results are not as good as expected. It does take many hours of operating experience to become an expert! We must emphasize that the best way to learn is to practice locating known objects.

### 1. BATTERY TEST

**RECEIVER:** Turn on the receiver by installing the earphone or speaker plug. Signal being received by the receiver will work the receiver battery as it is worked in normal operation, thus, the transmitter should also be turned on and the receiver Sensitivity control turned up when testing the receiver battery. Push the Battery Test switch for a battery voltage indication on the meter. Any meter reading in the Batt. OK scale indicates a good battery. A meter reading below the Batt. OK scale indicates the battery is low and should be replaced with an Eveready #216 or 9 volt equivalent.

*Note:* A safety check of the receiver battery is built in if the loudspeaker is being used. If the receiver audio and meter pulsates when a very low sensitivity setting is used, and the receiver is picking up signal from the transmitter, replace the receiver battery. A battery test will indicate a low battery.

**TRANSMITTER:** Rotate the Power control from the Off position to any Power setting. Rotate the function control to Battery Test. The small light on the face of the transmitter indicates a good battery if the light is on. A bright light indicates a fresh battery. A dim light indicates the battery is getting weak and should be checked more often. If the light fails to light, the battery is low and should be replaced with an Eveready #276 or 9 volt equivalent.

### 2. ON-HANDLE OPERATION

#### A. ASSEMBLY INSTRUCTIONS FOR ON-HANDLE OPERATION

Attach the base of the 4' handle to the face of the transmitter with the two black knobs. Make sure the two knobs on the front end of the 4' handle are facing the right direction. The front end of the 4' handle mounts to the plastic handle spanning the face of the receiver. Secure the front knob down tight. The back knob (spring loaded knob called "Null Adjust Knob") is only tightened down two complete turns after the little nickel plated cup touches the gray receiver handle.

#### B. ADJUSTING FOR A NULL BALANCE

If the null balance is set correctly, the instrument will provide outstanding results. Poor results will be found if the null balance is not set correctly.

Remove all wires, clips, or other loose parts from the accessory compartments. Move the instrument several feet away from any metal object, or further if it is a large object such as a car or metal fence. Standing over reinforced concrete or large metal objects that are buried will also limit the instruments null balance. If a null balance is not responding to the following null balance instructions, move to another area. A large metal object could be directly below the instrument that is limiting the ability to find a null balance.

Turn on the transmitter to the lowest power setting possible, just barely on. Set the function control to Inductive. Turn on the receiver and adjust the receiver Sensitivity control for a mid-scale reading. Hold the instrument as shown in Fig. 1. The ground will have some effect on the null balance, thus, the instrument should be held at a uniform height above the ground during adjustment and use. Select a height which is comfortable for carrying. The height you balance the instrument at, will be the height you operate the instrument.

With the meter at some mid-scale reading, turn the Null Adjust Knob in the direction which will cause the meter reading to decrease. When the meter approaches zero, increase the Sensitivity control to bring the meter reading back to mid-scale. Again turn the Null Adjust Knob to decrease the meter reading. Repeat these two steps until the Null Adjust Knob will no longer decrease the meter reading below some point on the meter scale. At this true null point, an adjustment of the Null Adjust Knob in either the direction will cause the meter to increase.

After the true null point has been determined, turn the Null Adjust Knob very slightly clockwise until the meter reading increases about one or two small scale divisions above the true null point. This is sometimes referred to as a "Plus Null," and is the most sensitive operating point for very weak signals. When the Plus Null has been set, turn down the receiver sensitivity to where the meter just shows an indication. The instrument is now ready to locate. Recheck the instrument for a Plus Null if soil conditions change, like walking from soil to asphalt.

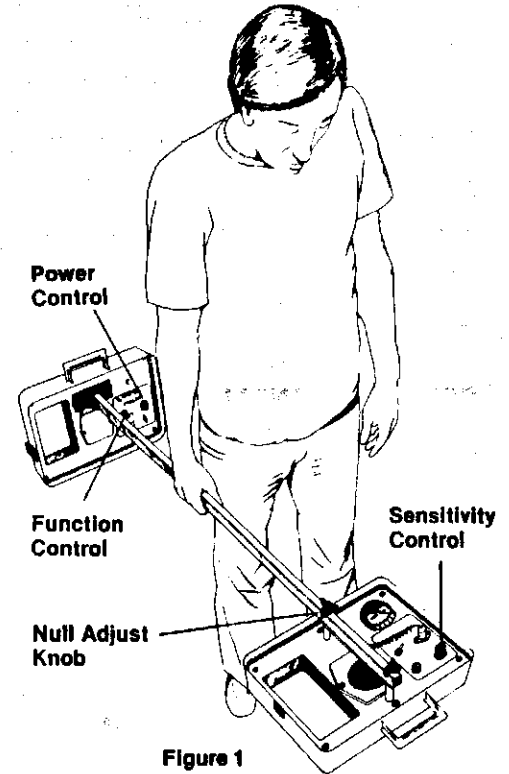

Figure 1

### C. OPERATING HINTS – ON-HANDLE

When looking for an unknown object, a flat metal object such as a manhole cover will be found under the receiver, and a pipe or cable will be found under the transmitter. The instrument must cross a pipe or cable at right angles to the direction the line is laying. It is easy to distinguish between a flat metal object and a pipe or cable by approaching the object from two directions. Mark the ground each time directly below the transmitter, but keep in mind where the receiver is. If the marks are below the transmitter each time, the target is a pipe or cable. If the target is under the receiver each time, the target is not a pipe or cable. It is a flat metal object such as a manhole cover or water meter lid. See Fig. 2, and Fig. 3.

After the location has been made, turn down the receiver Sensitivity control to where the meter will just barely respond to the target being located. This will help reduce the chance of other metal objects in the area of interfering with your location. Pipes and cables that are very close together can be separated if the receiver sensitivity is turned down.

### D. SUMMARY – ON-HANDLE USE

- a. The true null balance is when a rotation of the Null Adjust Knob in either the Clockwise or Counter-Clockwise direction will increase the meter pointer above some minimum point on the meter scale.
- b. A Plus Null is found when a slight Clockwise rotation of the Null Adjust Knob increases the meter one or two small scale divisions above the true null point.

- c. The transmitter should always be on the lowest power setting possible.
- d. Always check the instrument for a null balance when moving from one area to another.
- e. Pipes and cables are always located under the transmitter.
- f. Flat metal objects are always located under the receiver.
- g. After a location has been made, turn down the receiver Sensitivity control to where the target will produce a very slight meter indication when the instrument is directly over the target.
- h. Never swing, dip, or tilt the instrument when a location is being made. Always keep the instrument in the same position as it was when the null balance was being adjusted.
- i. Gate valves and water meter lids can be located with the receiver tilted to the ground, however the instrument should never be tilted if looking for pipes or cables.

#### E. LOCATING A MANHOLE COVER

Use the instrument On-Handle and set the Null Adjust for a Plus Null. Walking over a known manhole cover before looking for a lost one will help the operator determine how the instrument will respond to this type of location.

As the instrument approaches the manhole cover, the receiver will start picking up signal several feet away. A loud tone will be heard and the meter will go to full scale and remain there until the receiver is several feet beyond the cover. Turn down the receiver sensitivity until the highest meter reading is at some low point on the meter. The strongest signal will be found when the receiver is directly over the center of the manhole cover. Be sure to approach the target area from several directions. The mass of metal in a manhole cover is large and it is possible to obtain a reading on the cover from two directions and still not determine the exact position of the target. The receiver could be over the edge of the manhole cover. See Fig. 2.

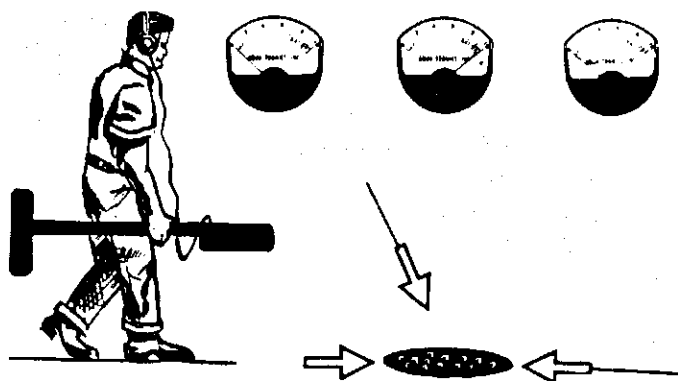

Figure 2

#### F. LOCATING A PIPE OR CABLE

Use the instrument On-Handle and set the Null Adjust for a Plus Null. Walk at a right angle across a known pipe and watch the meter for a maximum indication. When this occurs, mark a spot on the ground directly below the transmitter. Approach the pipe from the opposite direction, and again mark the spot under the transmitter. Half way between these two marks is the center of the pipe. You may have to turn down the receiver sensitivity if the maximum indication is off scale on the meter. See Fig. 3.

If other pipes or cables are known to be close to the line being located, drop the entire instrument as close to the ground as possible. Move the instrument back and forth over the location while adjusting the Sensitivity control to where the meter just barely indicates as the transmitter passes over the location. This will give the best results for centering a pipe, and other pipes in the area will have the least effect on the location.

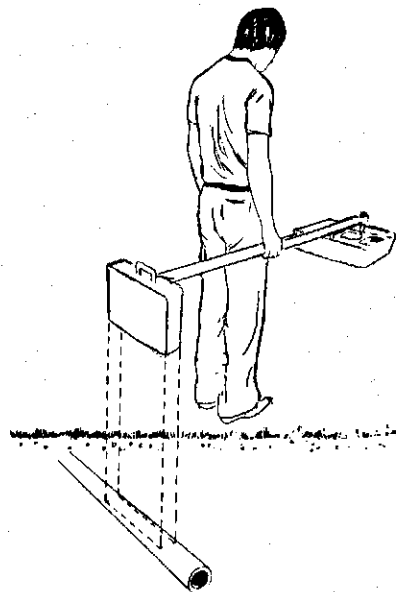

Figure 3

**G. LOCATING THE CENTER OF A FLAT METAL TARGET (manhole lid, water meter lid, etc.)**

Adjust the instrument for a null balance while holding the instrument as shown in Fig. 1. Move to the spot you found as a target. Hold the instrument in a vertical position as shown in Fig. 4. Move the backside of the transmitter over the target forward and backward. (Not sideways.) The receiver will pick up a signal on both sides of the target center and a distinct null will occur when the center of the transmitter is over the center of the metal object.

**H. LOCATING GATE VALVES OR WATER METER LIDS**

The instrument will locate a pipe when the transmitter passes over it at right angles. The transmitter will not locate a pipe when the locator is in-line with that pipe.

Adjust the instrument for a null balance and mark the exact route of the pipe. After this location has been made and marked, stand over the pipe and in-line with it. Tilt the receiver to the ground as shown in Fig. 5. The meter may increase to full scale, however, do not readjust the null balance. Turn down the receiver Sensitivity control to where the meter is reading 2 or 3

on the meter scale. Walk the route of the pipe very slowly while observing the meter. The meter will increase to a peak reading when it passes over the target. The instrument may show a sharp null reading just before the receiver passes over the target, but you are looking for a peak reading, therefore, the sensitivity should be reduced so that the peak reading can be seen when the center of the receiver is directly over the target.

You may now locate the size of the target by holding the receiver directly over the spot where the highest or peak reading was found. Adjust the Sensitivity control down to where the meter is reading 1 or 2 on the meter scale. Move the receiver to one side and then the other side. (Not forward and backward.) When the meter falls to zero, the center line of the receiver (receiver handle) will be in line with the edge of the target. When locating the edge of a round target such as a manhole lid, rotate around the target because the receiver must be moved sideways, not forward and backward.

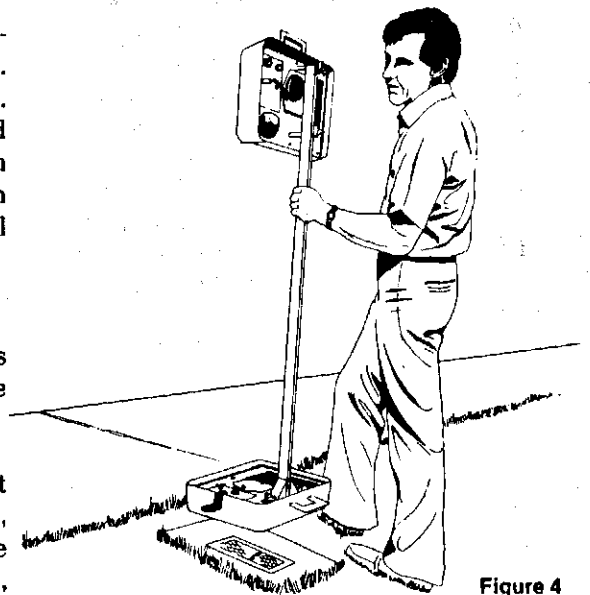

Figure 4

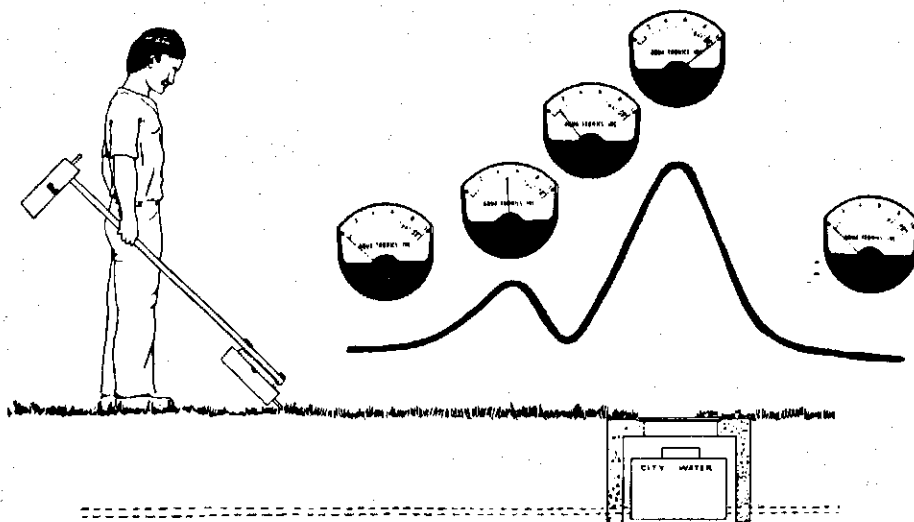

Figure 5

### 3. OFF-HANDLE OPERATION

#### A. DIRECT TRACING

The transmitter is attached directly to an exposed portion of the line to be traced. Use the cable clamp and the ground plate supplied with the instrument. Be sure the cable clamp is attached to clean bare metal. For maximum tracing range, the ground plate should be as far away from the transmitter as possible and at right angles to the direction of the pipe or cable. Most locations can be made by placing the ground plate near the transmitter.

Connect the cable clamp and ground plate leads to the transmitter. If possible, push the ground plate into the ground for a good earth connection. Pouring a bucket of water on the ground will also help insure a good earth connection for the ground plate in sand, dry soil, or on concrete if soil is not available. Switch the transmitter function switch to any one of the five Direct Output positions. Turn on the transmitter to a low power setting. For greater tracing range and deep locations, a higher power level may be required, but most locations can be made with the Power control just barely on.

With the transmitter connected and operating, turn on the receiver and set it down near the transmitter where the meter can be observed. Adjust the receiver Sensitivity control for a mid-scale reading. Adjust the transmitter through the 5 Direct Output positions and select the tap that gives the highest meter reading on the receiver. The Sensitivity control may have to be readjusted at some tap positions to observe the maximum meter indications. When the tap switch is at the position where the highest reading on the meter is obtained, the Direct Output is most closely matched to the cable or pipe being energized. The receiver can now be used to trace the position and depth of the line being energized. See Fig. 6, 7, and 8

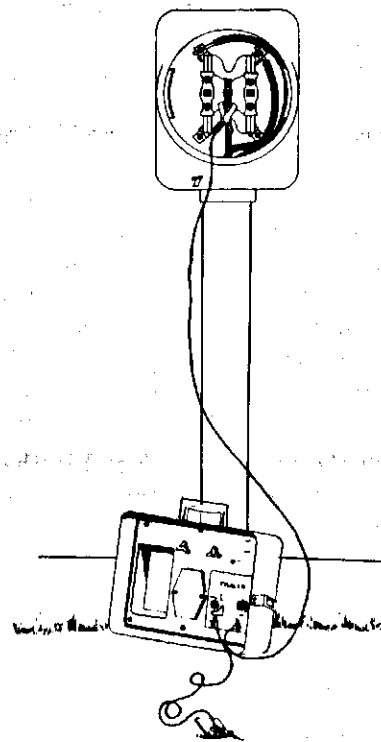
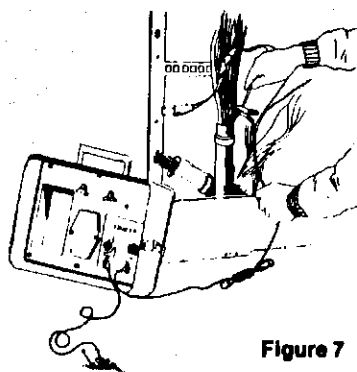
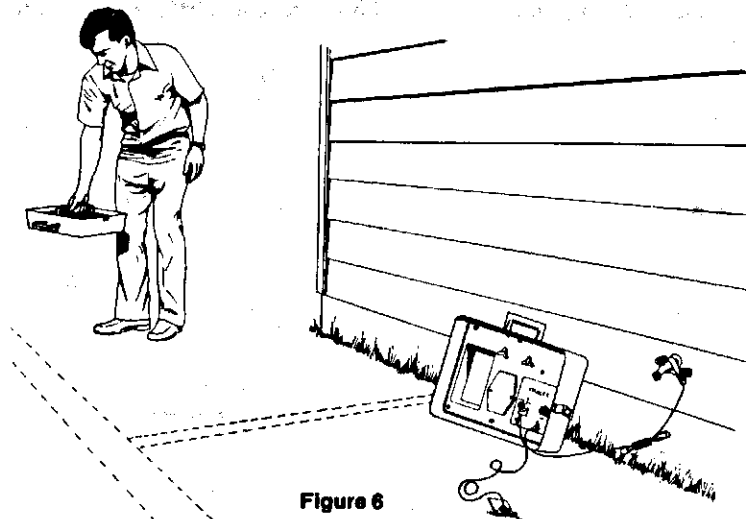

## B. LOCATING BY THE NULL METHOD

With the receiver being held level as shown in Fig. 9, the receiver will obtain a null (loss of signal) when the center of the receiver is directly over the line being energized. Signal will be found on both sides of the line, but a complete loss of signal (NULL) will be found directly over the line.

Do not tilt or swing the receiver. Tilting or swinging the receiver can cause an error in your location. The null should be very abrupt with signal returning one or two inches on either side of the null. If a wide null is present, increase the receiver Sensitivity control until the distinct null is found. It will help to determine the exact null by passing the receiver back and forth several times while the receiver sensitivity is being adjusted. When a distinct null is present, mark the ground directly below the center of the receiver.

Signal being radiated from a single pipe or cable will be round and the null will be easy to find. If more than one utility is in the same trench, or area, the signal being radiated from each utility can add together producing a distorted field. This distorted field can wash out a null to a point where the receiver cannot produce a distinct null. If the null cannot be found, go to the maximum method of locating.

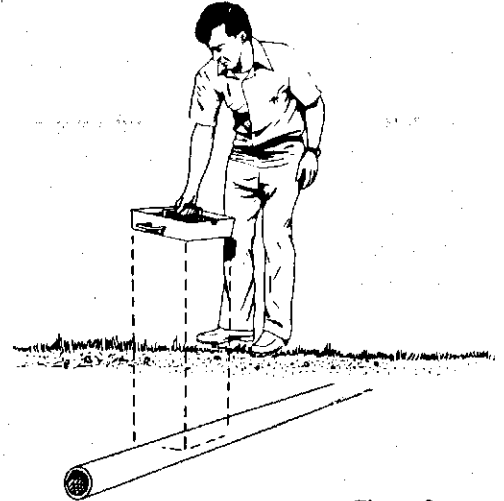

Figure 9

## C. MAXIMUM METHOD OF LOCATING

With the receiver held vertical and in-line with the pipe or cable being energized as shown in Fig. 10, a maximum or peak reading will be found as the bottom of the receiver passes over the line. If the receiver is held at right angles to the pipe, no signal will be found. The receiver must be in-line with the pipe or cable.

With the receiver held vertical and in-line with the pipe, signal in the earphone and meter will start increasing as you approach the pipe. As you pass over the pipe and start moving away on the other side, the signal will start falling off. Move back to the point where the maximum signal was found. With the receiver over your location, slowly rotate the receiver. When the bottom edge of the receiver is *in-line with*, and *directly over* the line being energized, a peak or maximum meter reading will be found.

Again, pass the receiver back and forth over the location while the Sensitivity control is reduced to that point where a very slight meter indication is found as the bottom side of the receiver passes over the line. This low meter response will help reduce the effect of other utilities in the same area which may also have signal on them. The lowest meter reading that can be seen will give the best results.

Do not swing the receiver. The bottom side of the receiver is pointing at the pipe for a peak reading. Swinging the receiver can cause an error in your location.

The Null method is probably faster for most locations, however null locations should be checked with the maximum method if you are needing absolute locations. If the null readings and maximum readings do not agree with each other, distorted field patterns are present and the maximum or peak reading will be the most accurate.

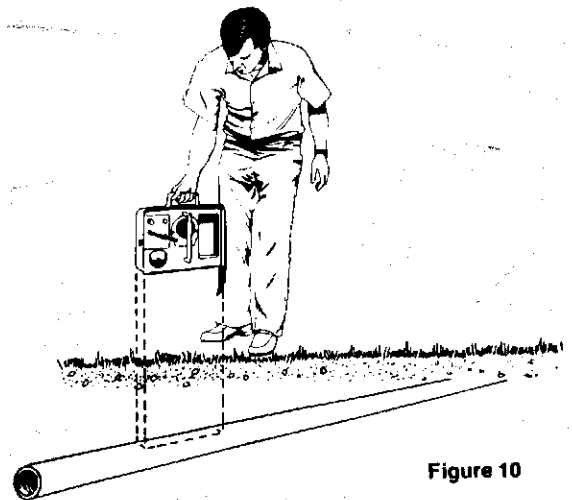

Figure 10



#### D. INDUCTIVE TRACING

Set the transmitter directly over and in-line with the pipe or cable to be traced. The function control should be switched to Inductive. Turn the transmitter on to the lowest power setting possible. More power can be used if needed, but low power will help reduce signal being applied to other utilities that may be in the same area. See Fig. 11.

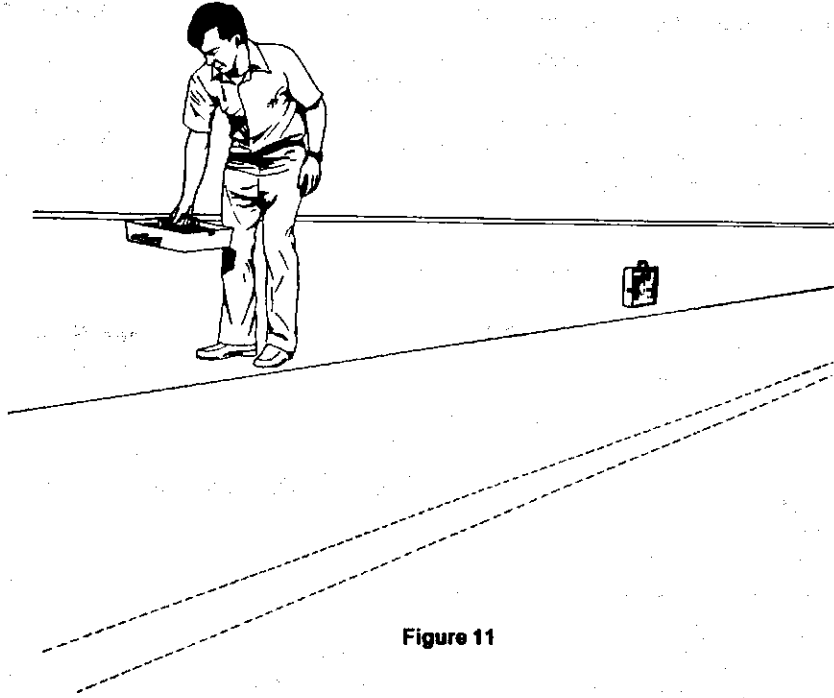

Figure 11

When the transmitter is set to Inductive, the receiver can also pick up the transmitter if you are close to it. On low power, the receiver should be at least 20 feet away from the transmitter before a location is made. If a higher power is used, move farther away. On high power you should be at least 50 feet from the transmitter. The receiver is used in either the null or peak method to trace your line. See Fig. 9, and 10.

Signal being radiated from the transmitter antenna not only penetrates the ground, but also permeates the air around the transmitter. The strongest signal will be found along the axis that is in-line with the transmitter case. If you have doubt as to having located a pipe or cable, or the transmitter itself, off-set the transmitter about 10 degrees off the route of the line being energized. If you still locate a line in the same position as before, you have a good location. If you cannot locate the line in the same area, check to see if you are now locating a new line that is in line with the transmitter case. If you do find this new location, you are too close to the transmitter and no line exists in that area.

#### E. TRACING WITH THE INDUCTIVE COUPLER

The only situation when the coupler should not be used is at a terminated end of a line. (Test caps, water faucets, dead end of a pipe or cable.) A limited performance will be obtained unless there is some length of conductor on both sides of the coupler.

A gas meter has an insulating gasket that insulates the house pipe from the incoming line. When coupling to a gas meter, this will be the end of pipe unless a jumper wire is used to bypass the insulating gasket. Connect a jumper wire from the shut-off valve (bare metal) to one of the screwheads on the face of the meter. A good trace can be made if the meter gasket is bypassed. See Fig. 12.

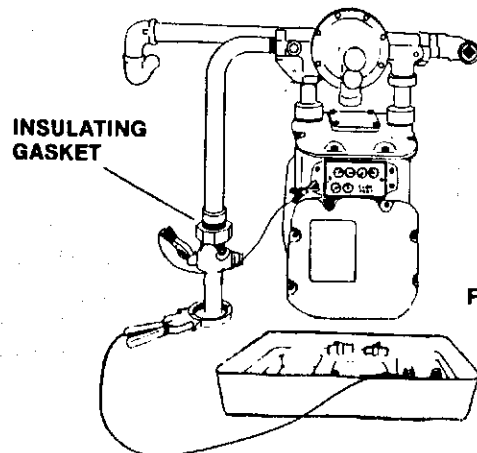

Figure 12

Connect the coupler terminals to the direct output terminals of the transmitter. Set the function tap switch to tap #2. This will set the impedance of the transmitter to the impedance of the coupler. Turn on the transmitter to low power and proceed with your location. The receiver can be used in the null or maximum method.

If you are obtaining wide peak readings, see item F.

The coupler can be placed around metallic or non-metallic ducts providing a metal conductor of some type is inside the non-metallic duct.

On telephone cables, always clamp around the cable below the sheath bond. This will induce the tone on the sheath. The coupler can be placed around a telephone service drop without removing the house protector cover. The 117.85 KHz tone is well above the audio hearing range and will not noise up a working cable. See Fig. 13 and 14.

A light weight machine oil should be applied to the hinge area several times a year.

The mating parts of the core material should be free of dirt or contamination at all times. Some tracing range can be obtained if the coupler is not closed, but maximum tracing will require the coupler to be completely closed.

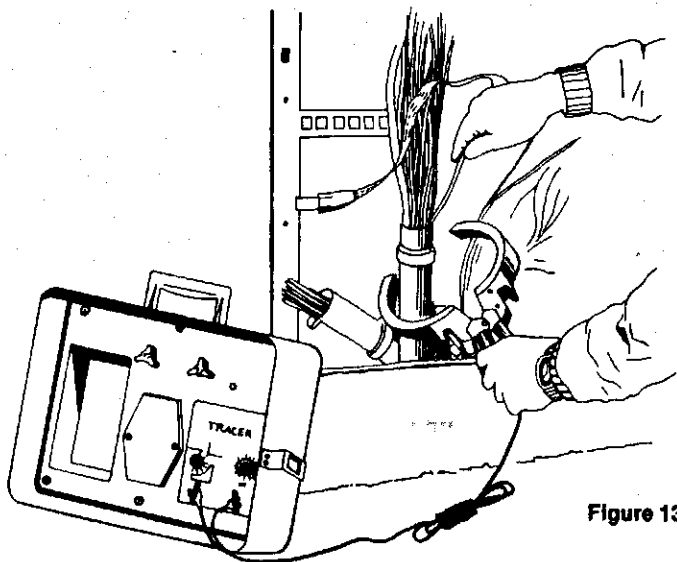

Figure 13

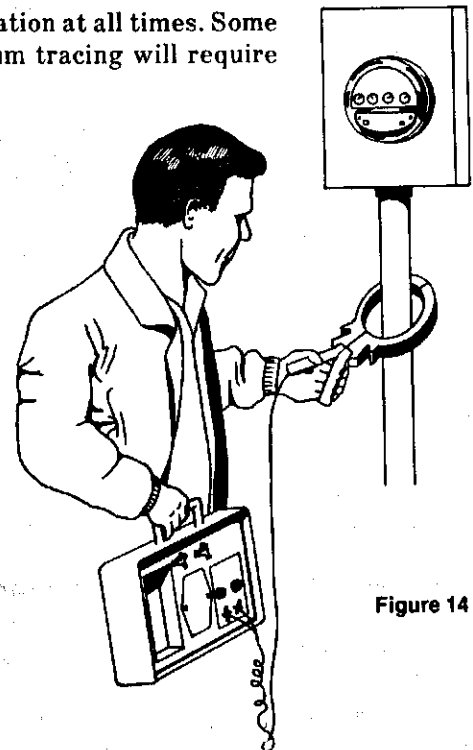

Figure 14

#### F. CORRECTING A WIDE OR BROAD PEAK READING

When using the Inductive Coupler or the Direct Output mode of tracing, there may be times when a wide or broad peak reading is found. Even on low power, the transmitter is placing too much signal on the line being traced and this is flooding the receiver.

Reducing the amount of signal the transmitter is placing on the line can be accomplished by mismatching the Direct Output of the transmitter. If the Inductive Coupler is being used, switch the output tap switch to tap #5. If a conductive trace is being used, switch that tap switch to one of the five positions that is farthest away from the correct tap number. This will reduce the signal level being placed on the line and a sharp peak reading can be found.

Always start your trace by setting up the tap switch to the correct tap number because it will provide the most range and depth. Only mismatch the tap switch when the broad or wide peak reading is present on a given location.

### G. DETERMINING DEPTH

After the position of the line has been located and marked, it is a simple matter to determine its actual depth.

When the position of a line is found by the Null method, the backside of the receiver is centered directly over the line. Mark this spot on the ground very carefully. If an error is made in the position of the line, your depth reading will then be in error.

Use the bubble depth gauge to determine the  $45^\circ$  angle. This will occur when the bubble is equally spaced between the small circle in the center and the black outer ring.

With the receiver as close to the ground as possible and held at a  $45^\circ$  angle, move away from the line with the back side of the receiver pointing in the direction of the line. Move away from the line until a null is obtained. Mark the ground directly below the center of the receiver. Measure the distance from this location to the location mark found directly over the line. The distance between these two marks will be the depth of the line. This depth will be very accurate if the receiver is held at ground level and at an exact  $45^\circ$  angle. See Fig. 15.

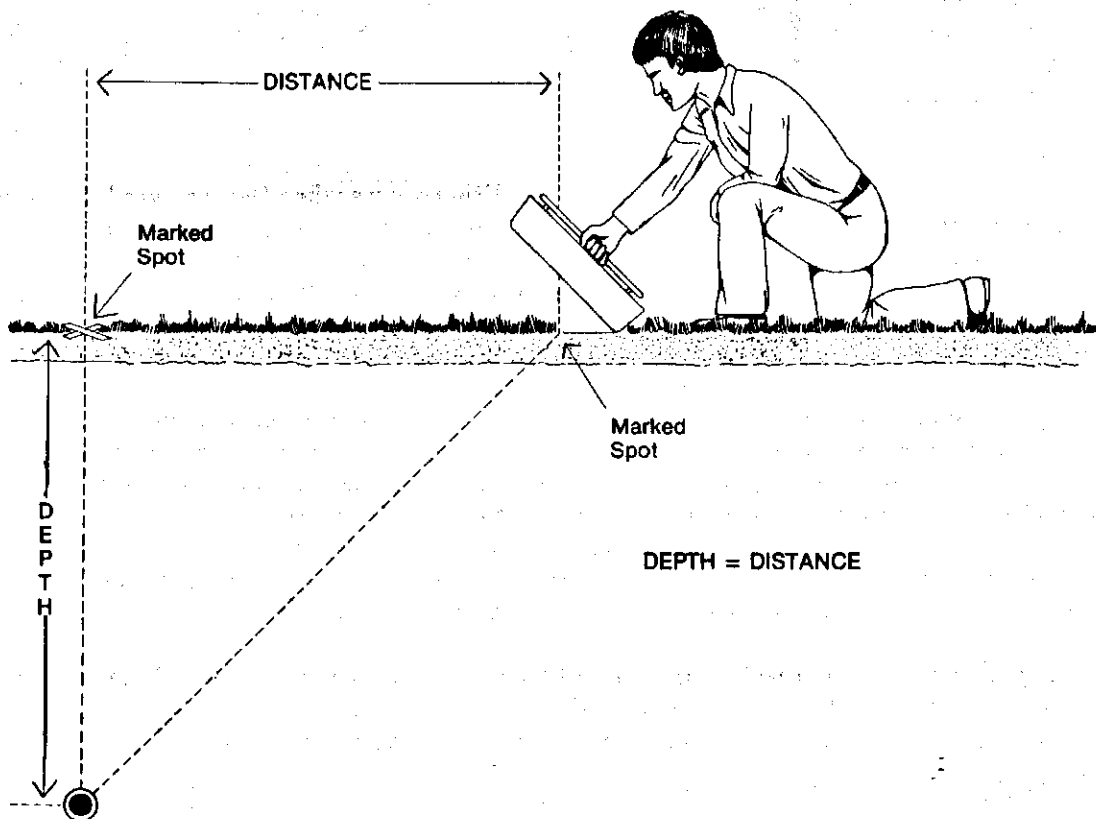

Figure 15

When working on a steep or rough ground, bear in mind that the distance is calculated at a  $45^\circ$  angle from the receiver case. The calculations will have to take into account any slope of the terrain, or the height that the receiver was held above the ground when making the depth measurement. When possible, the depth readings should be taken from both sides of the line. This will help reduce any error that might be present from distorted field patterns.

### III. THEORY OF OPERATION

The transmitter unit generates both an induction field and a radiation field surrounding its antenna loop. The energy in the induction field greatly exceeds that of the radiation field at the relatively short distances involved in metal locating, thus the applications described here can be explained almost entirely on the basis of induction theory. (This is true for distances up to approximately 1/6th of a wavelength.) The geometric pattern of the induction field may be plotted as indicated in Fig. 16 when viewed from one edge of the loop. The pattern is also symmetrical about the axis through the center of the loop; in other words, this would be the pattern parallel to the ground when viewed from directly above, or approximately the pattern extending above and below the ground when viewed from the side at a point near the surface of the ground.

The dotted outline at A indicates the position of the receiver loop with respect to the transmitter loop when mounted on the handle. This is one of the "null" positions for the receiver, which means there is no energy (signal) being coupled into the receiver loop.

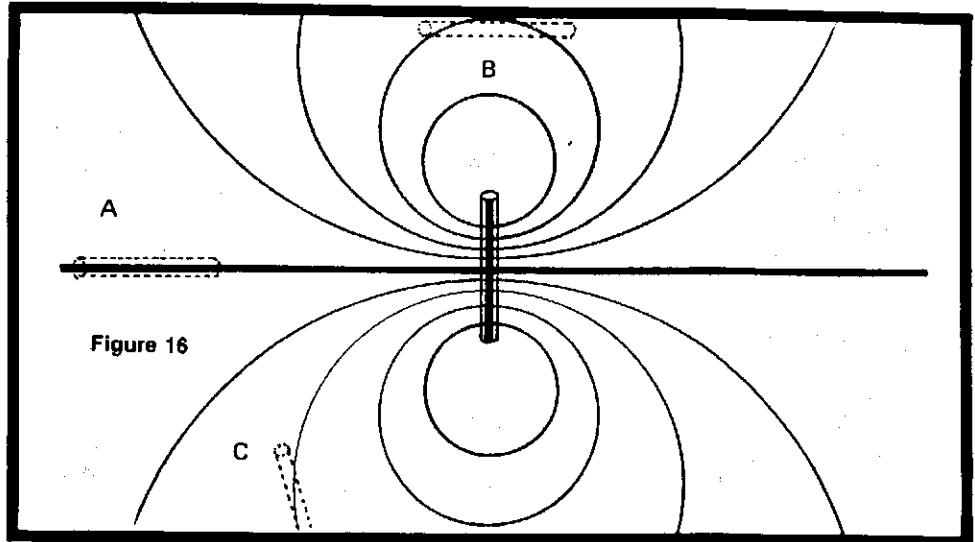

Notice that the null condition occurs when the receiver loop lies parallel to the direction of the induction field at that point. This is important, because it explains how the receiver loop can be used as a depth or direction finder in other applications. (This null feature of the receiver can be easily checked by removing it from the handle and positioning it for a null at various locations, such as those shown at B and C in the diagram.)

Many analogies, often misleading, have been used to explain the effect produced by a metal object, or objects, placed near the transmitter and receiver. The field theory involved is extremely complex; however a significant part relates to the mutual inductances existing between the two loops and the metal object. The effect of the mutual inductances is to couple energy into the metal object, producing currents which generate an opposing induction field. (This concept may be more familiar as the theory relating to loosely coupled transformers.) The interaction of the fields results in a slight change, or "distortion," of the transmitter field pattern. Thus if the receiver has been oriented for a null in the transmitter field, any slight change in the direction of this field due to the introduction of metal will cause some energy (signal) to be coupled into the receiver loop.

The foregoing implies that if the receiver is oriented for a null in a field which already includes a metal object, there should be energy coupled into the receiver when the metal is removed. Indeed this is true. Sometimes it can be useful, but for most work the instrument should be moved away from all metal objects when adjusting the null.

The theory also implies that the amount of inductive coupling between the transmitter loop and a metal object will depend upon several other factors: (1) the distance of the object from the transmitter loop, (2) the size and shape of the object, and (3) the direction of the major axis of the object with respect to the induction field. This latter applies particularly to the case of metal pipes or cables as shown in Figure 17.

Currents induced in a pipe or cable lying in a direction indicated by A-A' will tend to cancel, since the field links it twice. A pipe perpendicular to the field, as shown at B, C, or D, will have maximum induced current. The field strength at B is slightly less than at C, and is still less at D. Thus for "On handle" operation the pipe will have maximum effect on the field when the pipe locator is moved across the pipe, and least effect when moved parallel

to the pipe. Also, for a given depth, the pipe will have maximum effect on the field when the transmitter loop is directly over the pipe.

The foregoing theory also applies for line tracing, in which the transmitter and receiver may be separated a considerable distance. In this case the receiver loop is oriented to the relatively weak field generated by currents in the pipe. In order to induce maximum current in the pipe, the transmitter loop should be placed directly over the pipe and parallel to it. This would correspond to position C in Figure 17. (The receiver may be oriented either for a null, or for a maximum signal, depending upon the particular use.)

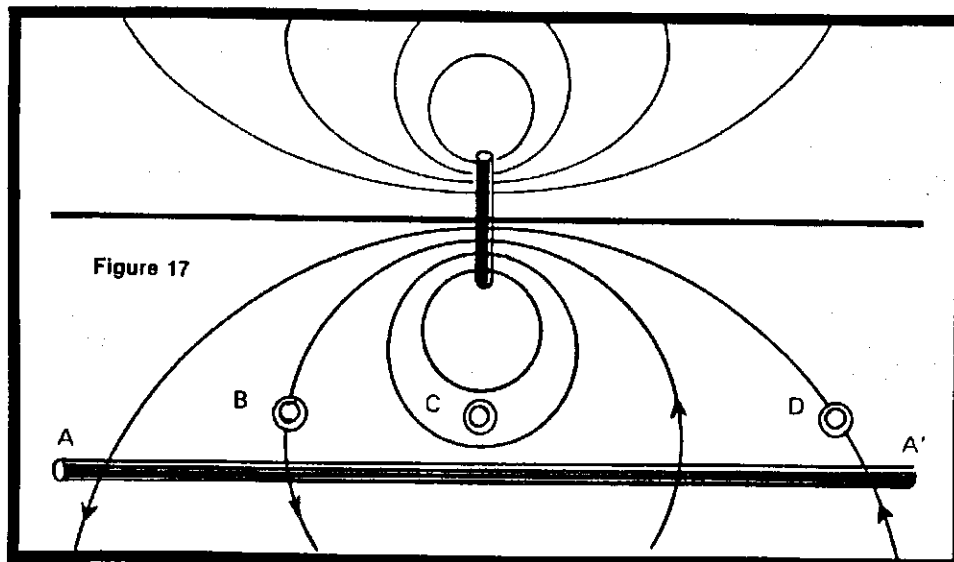

Figure 17

The effect of the ground itself (or water) should be mentioned, as it can be quite important in the operation of the pipe and line locator. The induction field of the transmitter generates currents not only in metal objects, but also in any other conductive material present in the field. Fresh water is a poor electrical conductor; soil may vary over a wide range from poor to fairly good, depending upon the amount of moisture and mineral content; and salt water is a reasonably good conductor. The currents generated in these materials will be distributed over a wide area, resulting sometimes in a significant distortion of the field pattern in the vicinity of the transmitter and receiver. (This causes a change in the null setting of the receiver for "On handle" operation.) More important, there is energy loss associated with these currents. The energy loss means a lower field strength for a given distance from the transmitter, thus less current is induced in a metal object at that distance. Likewise, there will be energy loss in the return direction for the field produced by current in the object.

The net result is that the metal object may have very little influence on the field in the vicinity of the transmitter and receiver if highly conductive soil or water conditions exist. Unfortunately, this is one of the fundamental limitations on the depth that an underwater or buried metal object can be detected.

#### IV. OPERATING INSTRUCTIONS FOR SEWER SNOOPER OR MINI-SNOOPER

1. The Sewer Snooper and Mini-Snooper are used for Non-Metallic pipe or duct location. The Snooper is a small radio transmitter that will attach to a conventional rodding machine or sewer tape. It is forced through the pipe or duct while the Model A6 receiver is used to accurately trace its position and depth. This method of locating non-metallic lines is far more effective than energizing a metal tape.

**The Sewer Snooper:** 2" dia. x 6½" long and can be located up to 50' deep. It will negotiate a 4" clean out and should be used in 4" dia. pipes and larger.

**The Mini-Snooper:** 1½" dia. x 4" long and can be located up to 25' deep. It will negotiate a 90° bend in a 3" pipe if connected to a flexible leader of some type.

Sewer Snooper Battery - Eveready #216 or 9 volt equivalent.

Mini-Snooper Battery - Eveready #544 or Mallory PX-28B Silver Oxide 6 volt or equivalent. This battery can be found in most stores selling Canon or Nikon photo flash equipment.

A new battery will provide about four (4) hours of continuous operation. A new battery should be used when locating a line near the maximum depth limitations of the Snooper being used.

## 2. Familiarization

Before trying to locate a pipe underground be sure to familiarize yourself with the basic operation of the transmitter and receiver. The following procedure simulates actual operating conditions, and should be useful as a guide.

### A. Operating Tests

Turn the Snooper transmitter ON and place it on the ground where it can be seen. Turn the receiver ON by plugging in the earphone or speaker. Adjust the receiver Sensitivity control until a mid-scale reading is obtained on the meter.

Walk away from the transmitter, and note that the meter indication and audio signal will start to decrease. Conversely, when walking toward the transmitter, the signal will increase. This simple operation can be very useful in finding the approximate location of the transmitter underground.

A procedure to locate the transmitter precisely is described as follows:

*Note:* The receiver must be held level, and at a height of at least two feet above the ground for this test. The Depth Gauge bubble level can be used to determine when the receiver is level, and also when it is 45° from level.

**Step 1.** Walk in a large circle around the transmitter which was placed on the ground. Adjust the receiver Sensitivity control for a mid-scale reading on the meter.

**Step 2.** Notice that when the receiver is moved past a point exactly at a right angle to the transmitter, the meter will drop to zero, then quickly move back up-scale. As the meter goes to zero the audio signal will also decrease. This sudden drop in signal will be referred to as a "NULL" throughout the rest of the manual. Move the receiver back to the point where the null was obtained.

**Step 3.** Try increasing the Sensitivity control, and repeat Step 2. Notice that as the sensitivity is increased the null becomes very sharp. However, if the sensitivity is set too high you may pass through the null point without seeing any indication, because the meter will not respond fast enough. Increase the Sensitivity control only enough to get a sharp null, then mark a spot on the ground directly below the center of the receiver.

**Step 4.** Adjust the Sensitivity control until the meter reads in the upper half of the scale. Continue walking around the transmitter until a second null point is found on the opposite side of the transmitter. Increase the sensitivity for a sharp null, then mark the spot on the ground under the receiver. Note that a line connecting these two null points would pass through the transmitter. (See Fig. a.) No matter how many circles are made, or the diameter of the circles, all of the null points will line up with each other. An imaginary line drawn through all of the null

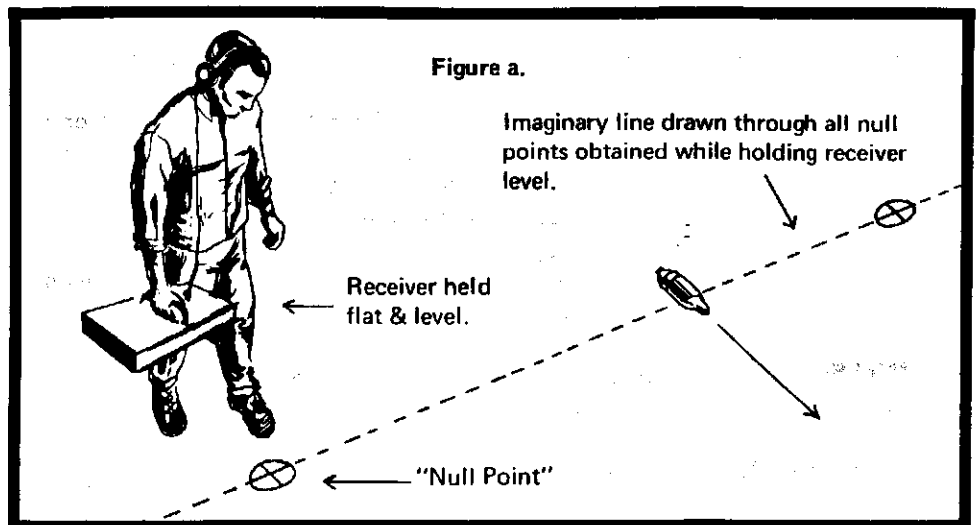

points will cross the transmitter at a right angle to the direction in which the transmitter is pointing. (The receiver must be held level as shown in Fig. a.)

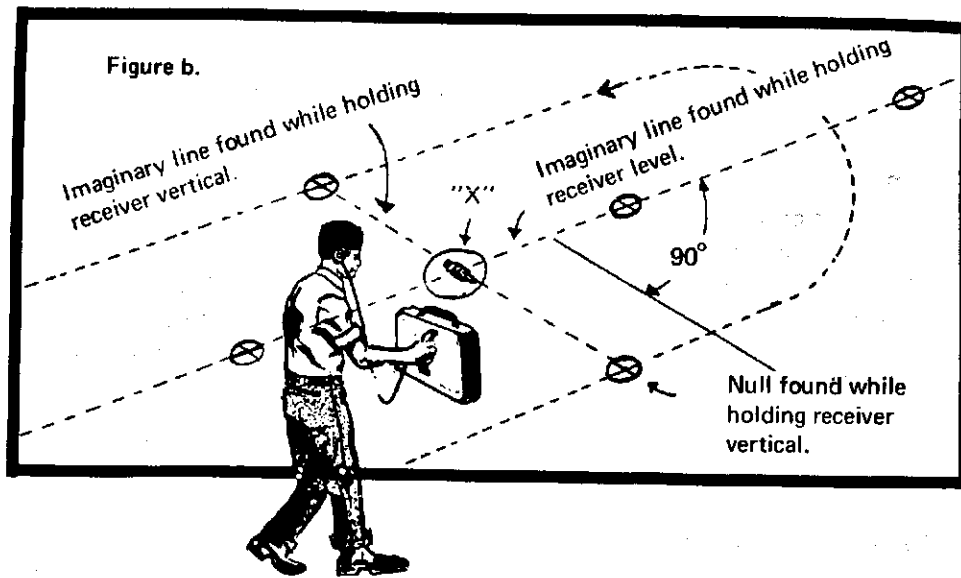

**Step 5.** Next, hold the receiver vertical and walk in a line parallel to the imaginary line found in Step 4, but keep about 5 feet away from it. At some point a null will be obtained. Increase the sensitivity for a sharp null, and mark this spot on the ground as shown in Fig. b. Keep the receiver vertical and exactly at a right angle with the imaginary line as you walk. Continue on a short distance, then move to a point about 5 feet on the other side of the imaginary line. Walk a parallel line in the opposite direction. Again mark the null point. Now, if another imaginary line

is drawn between the two null points found in this step, the point where the two lines cross should be the exact location of the transmitter.

*Note:* A good proficiency check is to have someone hide the transmitter for you to locate. Don't panic! Go back to Steps 1 through 5, and you will not only locate the transmitter, but the direction of its axis can also be determined.

## B. Summary of Preceding Steps

1. Hold the receiver level. Walk in a circle (or the direction in which the signal increases) until a null is found.
2. Increase the sensitivity and mark the null spot.
3. Continue around the circle until the second null is found and mark this spot. Connect the two null spots with an imaginary line.
4. Hold the receiver vertical and walk 5 feet away from the imaginary line, but parallel to it. Find the null on both sides of the imaginary line and mark these two spots. Connect them with an imaginary line.
5. "X" marks the location of the transmitter.

*Note:* Both nulls points found in steps 1, 2 & 3 could be on the same side of the transmitter. Keep walking during step 4 until a null is found. The imaginary line from steps 1, 2 & 3 is a straight line as shown in Fig. b.

## 3. Locating a Non-Metallic Pipe

### A. Connecting Transmitter to Rodding Machine

Remove the end cap from the Sewer Snooper, and attach this cap to the rodding machine, snake, or tape. Turn on the transmitter and listen for the tone in the headphones. Screw the transmitter back onto the end cap, and make sure it is on tight. Inject the transmitter into the pipe.

Follow Steps 1 through 5 described in the preceding section for locating the Sewer Snooper as it moves through the pipe.

*Note:* The Sewer Snooper will *not* broadcast its whereabouts inside a metallic pipe. A sudden loss of signal may indicate that the transmitter has entered a metallic pipe that connects to the non-metallic line. There will be a tone change as it nears the metal pipe, and then all tone will disappear as it enters the metal pipe.

## B. Adjustment of Rodding Machine Clutch

The Sewer Snooper is rugged, but not indestructible. Care should be used when fastened to a rodding machine of any type. Adjust the clutch such that any obstruction will make the rodding machine slip, and use only enough clutch tension to insert the transmitter.

Another precaution is to avoid spinning the rod, if possible. In a large pipe, spinning the rod will cause the transmitter to whip against the sides of the pipe. The Sewer Snooper cannot be treated like a root saw, or an auger, but with a little care it will last for a long time.

## 4. Locating Metal Inside a Non-Metallic Pipe

This ability can be demonstrated by turning on the Sewer Snooper transmitter and receiver and placing the Snooper near a metal object. Notice that a change in pitch of the sound in the headphones will take place when the Sewer Snooper is brought close to the metal. The Sewer Snooper may not detect a large piece of metal outside of a non-metallic pipe, but it will respond to a very small metallic object inside the pipe. This feature of the Sewer Snooper is very useful in locating such items as a root saw, or a broken tool of some type in the pipe; also it can be used to determine whether an obstruction is caused by a metallic object.

Most types of metal will make the tone increase in pitch; however some types of metal make the tone decrease in pitch. When searching for a specific metal object, such as a root saw, or a broken tool of some type inside a sewage pipe, try holding the Sewer Snooper near a like object. Listen for the change in pitch of the tone — this tone change may help in identifying the object in the pipe.

## 5. Determining Depth of the Sewer Snooper

Once the location of the transmitter is precisely determined, hold the receiver at a 45° angle as shown in Figure d. Back away until a null is found. The distance from this null point to the spot marked as "X" over the transmitter is equal to the depth of the transmitter below the spot marked "X." (Note that this depth is to the transmitter rather than the center of the pipe.) See Fig. d.

*Note:* If trouble is encountered in finding a null with the receiver held at 45°, go back and carefully check the four null points in Steps 1 through 5. To find the exact depth, the receiver must be parallel with the imaginary line from the null points found while holding the receiver vertical, as shown in Figure c.

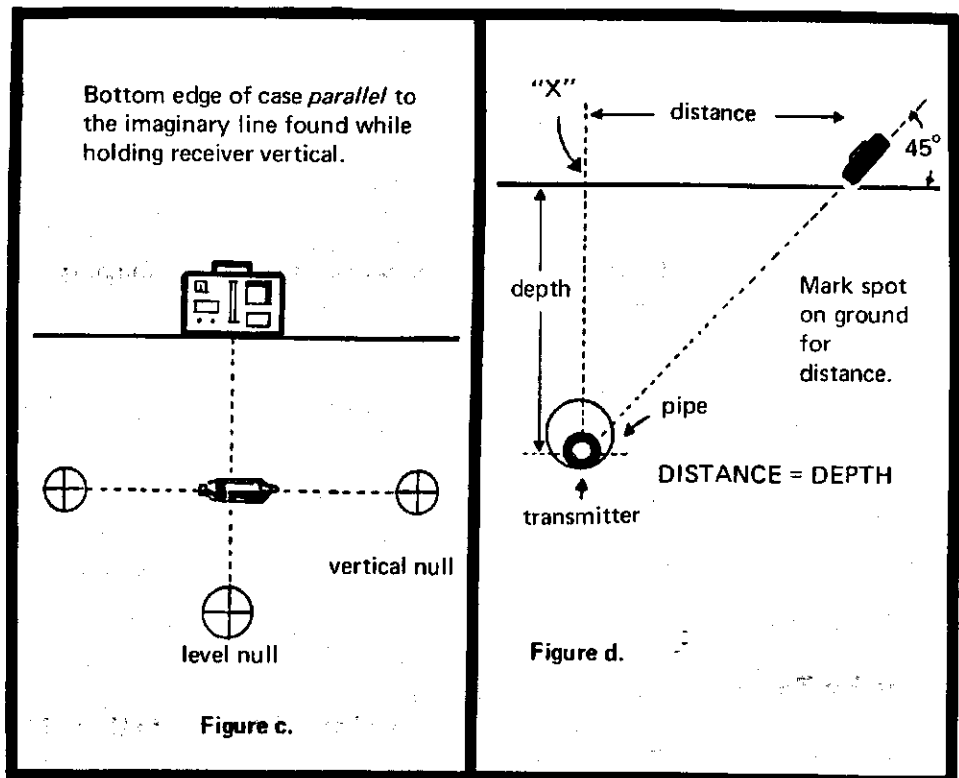

## 6. Sanitation Warning

Hepatitis and many other serious diseases can be contracted by handling objects contaminated in sewage pipes. Aqua-Tronics, Inc. assumes no liability for any injury, sickness, or accident to personnel or property from using our instruments. We recommend that a good waterless hand soap with a commercial disinfectant be used to clean the Sewer Snooper immediately after each use.



**7. Tuning the Sewer Snooper or Mini-Snooper to Your Receiver**

Turn on the receiver and Snooper. Turn the Sensitivity control to #5 on the dial.

Use a small screw driver and adjust the small screw inside the Snooper in the direction that the tone or pitch DECREASES. Adjust the screw until the tone in receiver decreases to a point where you have no tone coming from the receiver. At this point, an adjustment in either the counter-clockwise or clockwise direction of the small screw will bring the tone back. From this no-tone position, adjust the screw in the counter-clockwise direction until you have a good rich audio tone in the receiver. Hold a watch or piece of aluminum near the antenna section of the Snooper. If the tone increases when the metal is near the antenna, the Snooper is tuned and is ready for use. If the tone decreases as the metal is placed near the Snooper antenna, start over. You did not adjust counter-clockwise from the no-tone position.

**V. SERVICE AND WARRANTY**

**Instrument Service**

If for any reason you have trouble, or require assistance with your instruments, contact the nearest Aqua-Tronics sales outlet. You may, if you so desire, write or call directly to Aqua-Tronic, Inc. manufacturing plant and give full details of your problem, or needs.

**Warranty**

All Aqua-Tronics products are warranted against defective materials and workmanship.

The Model A6 Tracer has a two year warranty and the Inductive Coupler, Sewer Snooper and Mini-Snooper has a one year warranty.

Aqua-Tronics will repair or replace all products which prove to be defective during the warranty period. All repair will take place at our manufacturing plant or one of our field Service Centers. The decision of determining warranty defects from abuse or breakage, and where the instrument is to be repaired, lies with Aqua-Tronics, Inc.

If you send your instrument in for factory service, please send it pre-paid. If the service is covered under warranty the instrument will be returned pre-paid. If the instrument is not covered by warranty the instrument will be sent to you C.O.D.